

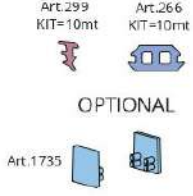

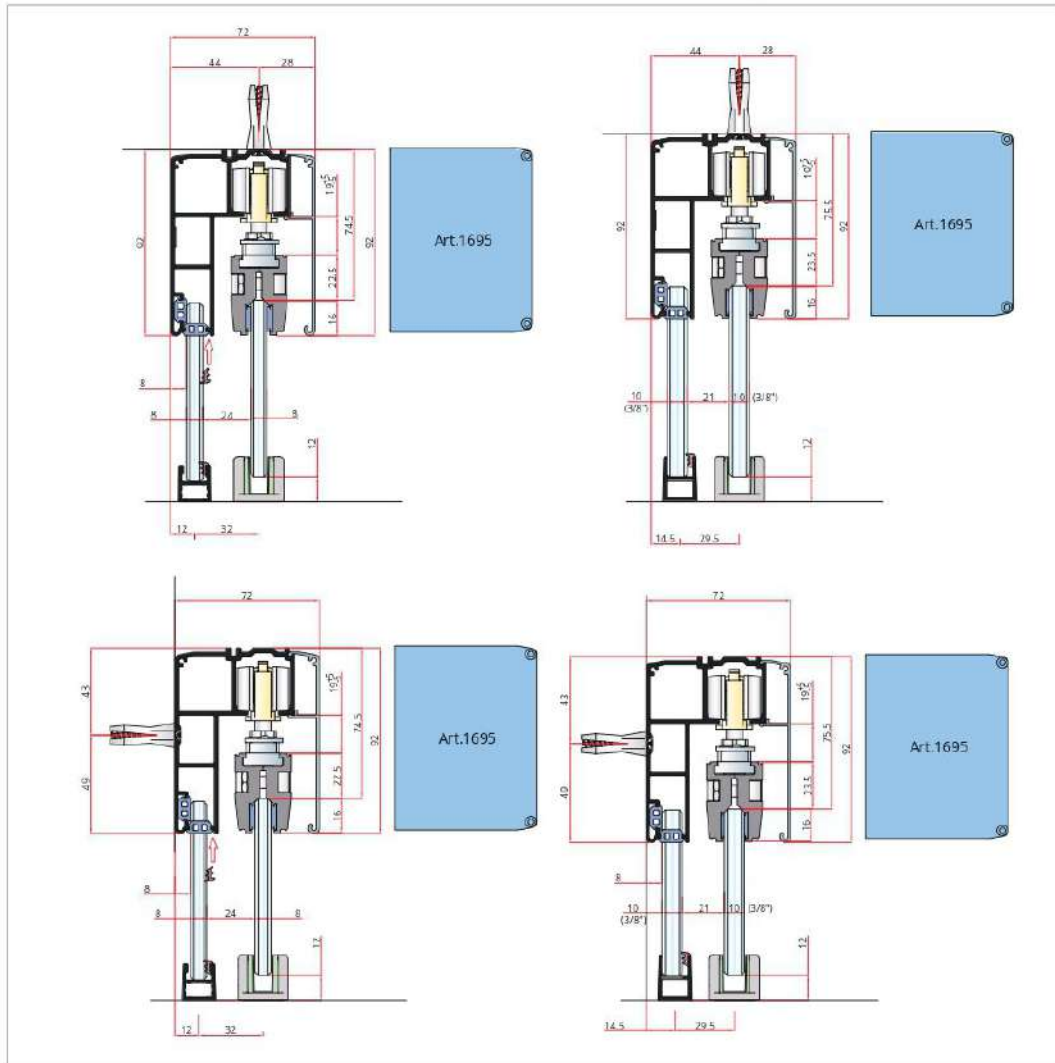

Mechanisms for Glass Drag Doors

Size description

ALUMINIUM TRACKS	SEAL
	 <p>Art.299 KIT=10mt</p> <p>Art.266 KIT=10rmt</p> <p>OPTIONAL</p> <p>Art.1735</p>

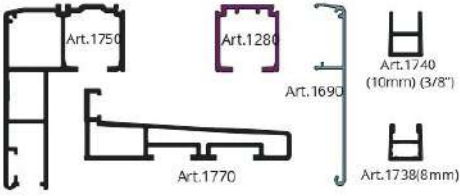
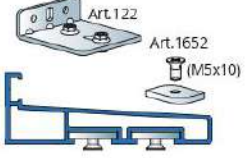

Drag doors



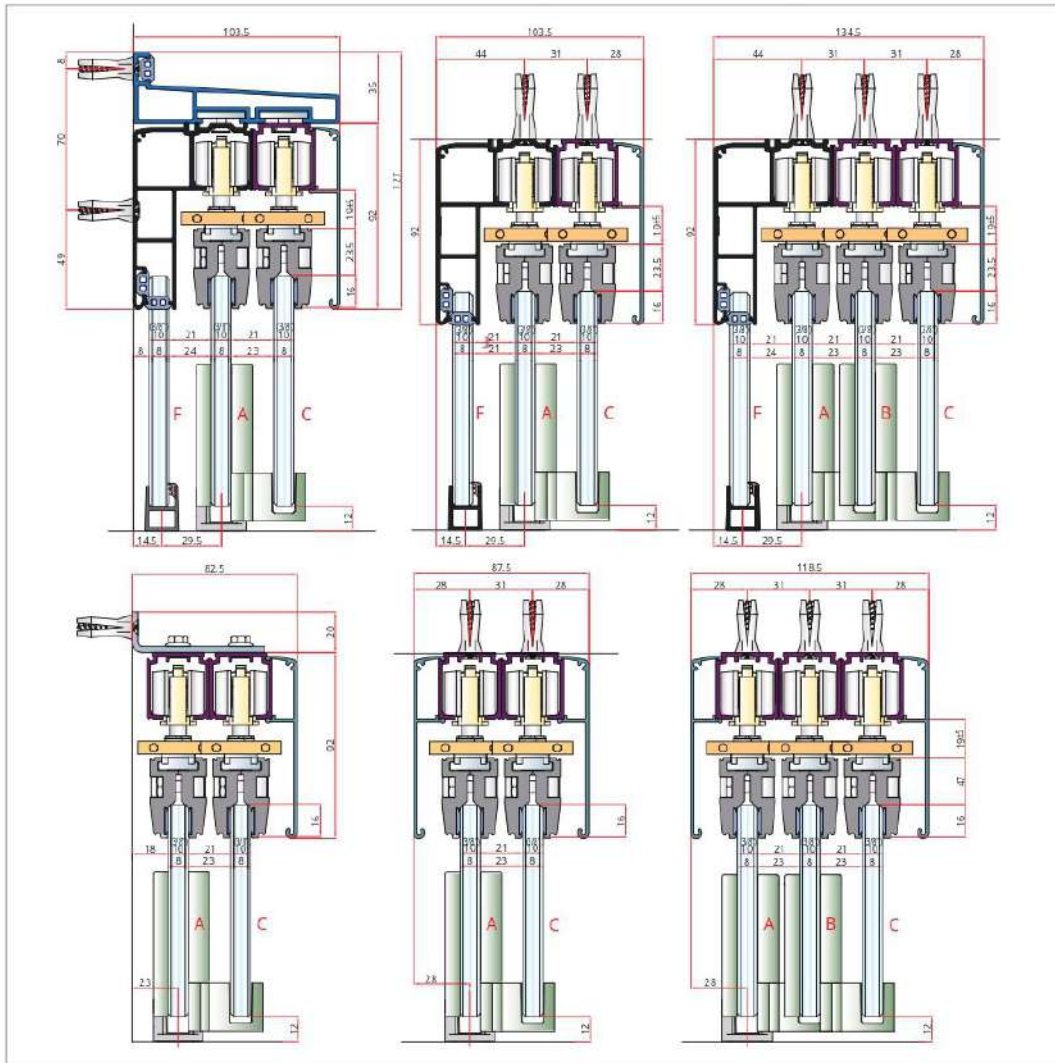



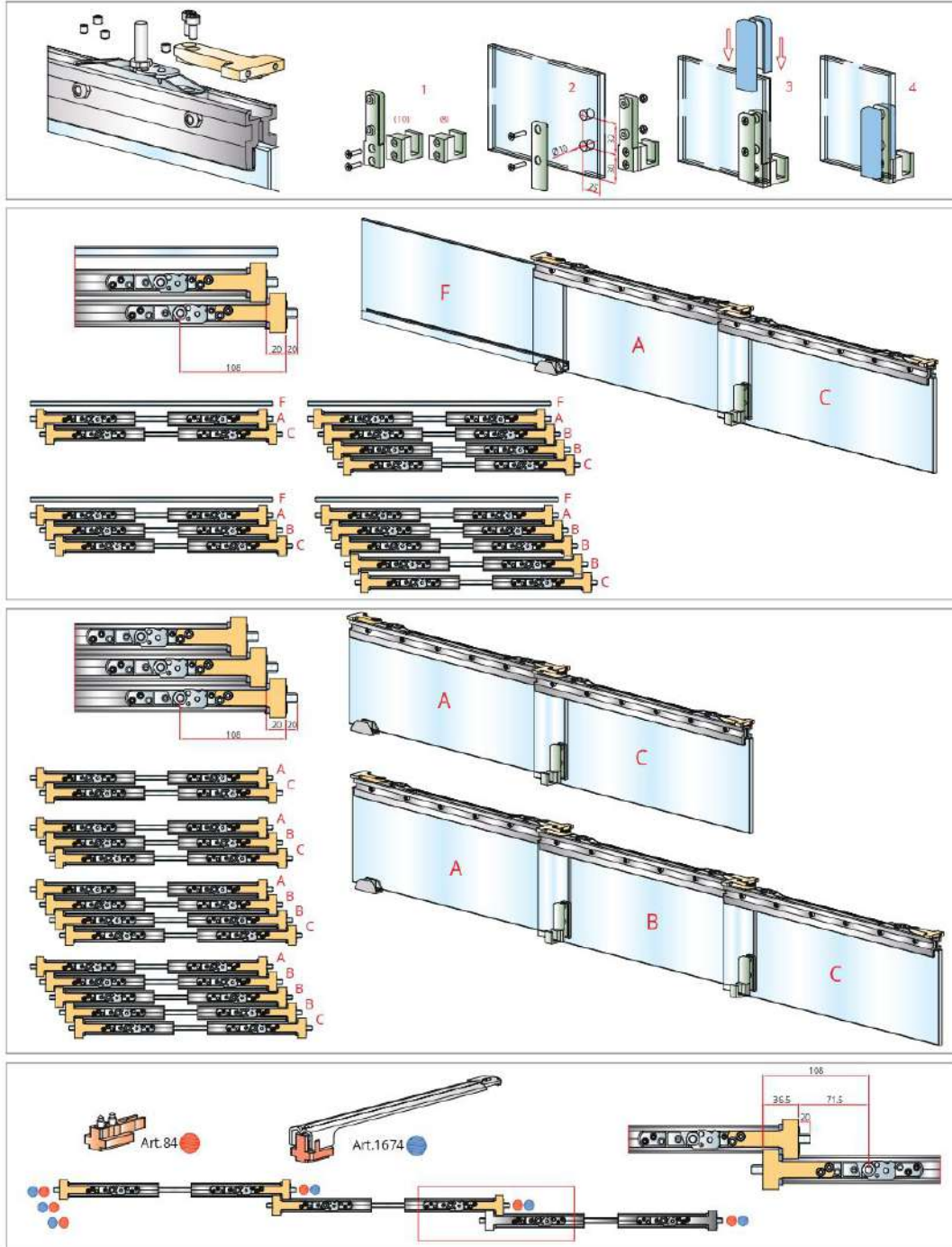



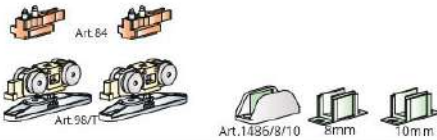

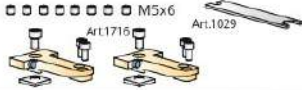
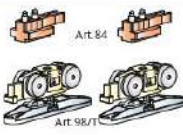

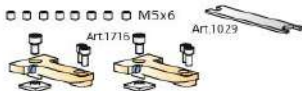
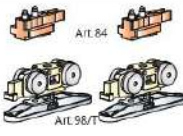



UPPER ALUMINIUM TRACKS	FIXING WALL	SEAL
		<p>Art.259 KIT=10mt Art.266 KIT=10mt</p>  <p>OPTIONAL</p>



System description

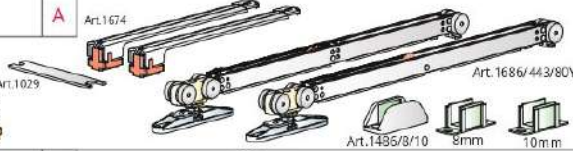

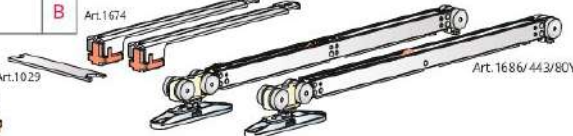
Kit for drag doors

 KIT FOR ONE DOOR min.600mm	ART.1716/98/98/A A		
	 ART.1716/98/98/B B		
	 ART.1716/98/98/C C		
 KIT FOR ONE DOOR min.670mm	ART.1716/98/1686/A A		
	 ART.1716/98/1686/B B		
	 ART.1716/98/1686/C C		
 KIT FOR ONE DOOR min.1030mm	ART.1716/1686/1686/A A		
	 ART.1716/1686/1686/B B		
	 ART.1716/1686/1686/C C	